

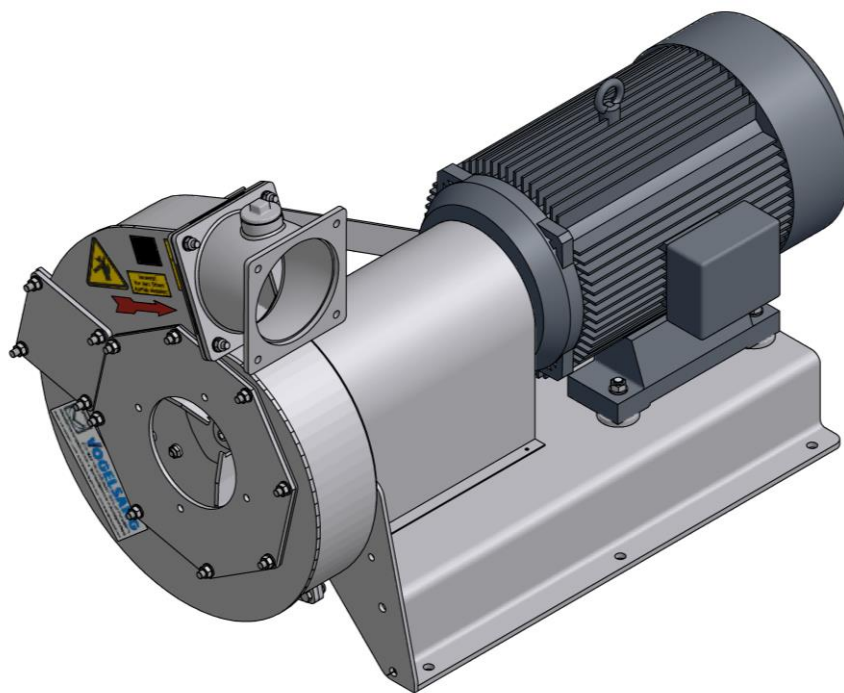

Ersatzteilliste

PowerFill
mit Elektromotor

ENGINEERED TO WORK



Herausgeber

Hugo Vogelsang
Maschinenbau GmbH
D-49632 Essen/Oldb.



+49 54 34 83 0



+49 54 34 83 10



info@vogelsang-gmbh.com



www.vogelsang.info

Der Nachdruck dieses Dokumentes, auch auszugsweise, gleichgültig in welcher Form, ist ohne ausdrückliche, schriftliche Genehmigung des Herausgebers verboten.

Gegenüber Darstellungen und Angaben in diesem Dokument sind technische Änderungen, die zur Verbesserung der Maschine notwendig werden, vorbehalten.

© 2010 Hugo Vogelsang Maschinenbau GmbH

Registrierte Vogelsang-Marken

Vogelsang, Vogelsang Logo, RotaCut, HiFlo, ACC, CFC und BioCrack sind eingetragene Marken der Hugo Vogelsang Maschinenbau GmbH.

Die registrierten Marken werden in diesem Dokument nicht immer mit einem ® gekennzeichnet.

Inhaltsverzeichnis

Abbildung: PowerFill 4
Gehäuse 5
 Pos. 1 5
Deckel und Dichtung 5
 Pos. 2-3 5
Rotor und Zubehörteile 5
 Pos. 4-11 5
Adapter mechanischer Antrieb 5
 Pos. 12-29 5
Flansche und Schrauben 6
 Pos. 31-36 6
Sicherheitsrelevante Aufkleber 6
 Pos. 38-42 6
Werkzeuge 6
 Pos. 44 6
Abbildung: elektrischer Antrieb 7
Aufnahme 7
 Pos. 45-46 7
Adapter 7
 Pos. 47-49 7
Kupplung HEXAFLEX 8
 Pos. 50-53 8
Elektromotor und Schutz 8
 Pos. 55-57 8
Schrauben + Zubehör 8
 Pos. 58-71 8

Abbildung: PowerFill

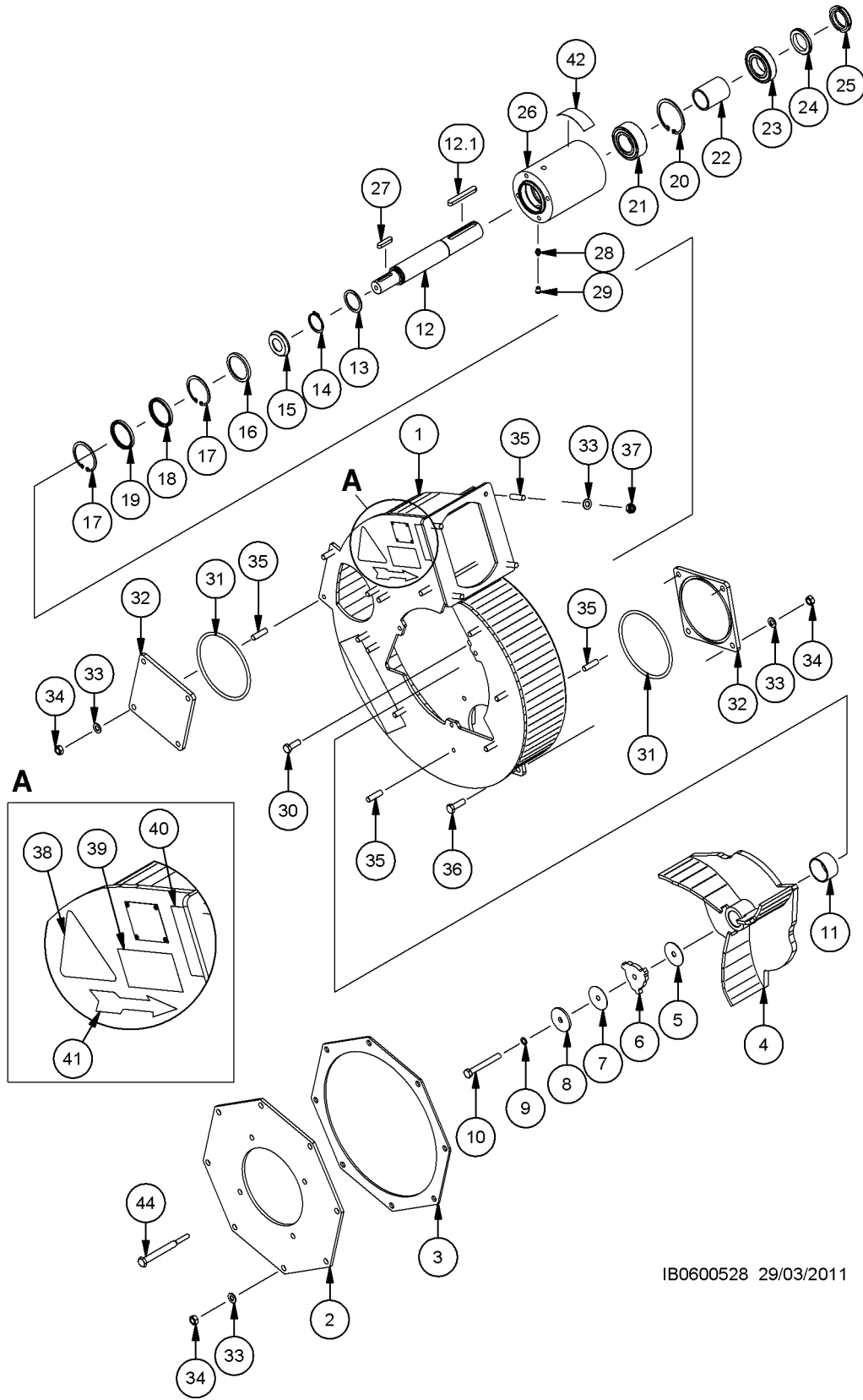

IB0600528 29/03/2011

Gehäuse

Pos. 1

Pos.	Teilenummer	Bezeichnung	Abmessungen	Bemerkung	Rep.	Menge
1	GSK.205.N2	Gehäuse		8"-Anschluss		1
	GRC.201.N3	Gehäuse		6"-Anschluss		

Deckel und Dichtung

Pos. 2-3

Pos.	Teilenummer	Bezeichnung	Abmessungen	Bemerkung	Rep.	Menge
2	GRC.206	Deckel		8"-Anschluss		1
	GRC.202	Deckel		6"-Anschluss		
3	DFD.032	Flansch Dichtung				1

Rotor und Zubehörteile

Pos. 4-11

Pos.	Teilenummer	Bezeichnung	Abmessungen	Bemerkung	Rep.	Menge
4	TRO.400.N3	Rotor				1
5	DFD.115.T1	Flachdichtung	60 x 13 x 1,5	ABIL		1
6	RFL.437.T1	Abziehvorrichtung		Rotor		1
7	DFD.044.T1	Gummischeibe	60 x 12 x 1			1
8	NUS.001.T1	Vorspannscheibe	60 x 13 x 5			1
9	DKR.002	Kupferring	A 12 x 18 x 2	DIN 7603		1
10	NSK.152	Sechskantschraube	M12 x 110	DIN 931		1
11	NIR.023	Innenring	JR 55 x 60 x 35	In TRO.400.N3 enthalten		1

Adapter mechanischer Antrieb

Pos. 12-29

Pos.	Teilenummer	Bezeichnung	Abmessungen	Bemerkung	Rep.	Menge
	TMA0002	Adapter mechanische Antrieb; Welle mit Passfederverbindung		enthält Pos. 12-29		(1)
12	TAW0002	Antriebswelle		Passfederverbindung		1
	NPF.046	Passfeder	A 12 x 8 x 45			1
13	NUS.111	Stützscheibe	45 x 56	DIN 988		1
14	NSR.059	Sicherungsring	A 45 x 23	DIN 471		1
15	PRS.616	Sicherungshülse				1
16	DWD.070	Wellendichtring	60 x 72 x 7	NBR Edelstahl-Feder		1
17	NSR.025	Sicherungsring	72 x 2,5	DIN 472		2
18	DWD.050	Wellendichtring	60 x 72 x 7	NBR Niro-Feder		1
19	DWD0002	Wellendichtring	60 x 72 x 7	Ohne Feder		1
20	NSR.003	Sicherungsring	85 x 3	DIN 472		1
21	NLG0001	Schräggugellager		Zweireihig		1
22	PRS0005	Abstandshülse	45 x 54 x 69,8			1
23	NLG.033.T1	Rillenkugellager				1
24	NMN.008	Nutmutter	M45 x 1,5	DIN 981		1
25	NMN.002	Nutmutter	M45 x 1,5	GUK		1
26	TLG0001	Lagergehäuse				1
27	NPF.053	Passfeder	A 10 x 8 x 45			1
28	NKS.001	Schmiernippel	M10 x 1			1
29	BKA.001	Schmiernippelkappe	GPN 985			1





Flansche und Schrauben

Pos. 31-36

Pos.	Teilenummer	Bezeichnung	Abmessungen	Bemerkung	Rep.	Menge
30	NSK.028	Sechskantschraube	M12 x 30	DIN 933		4
31	DOR.016	O-Ring	160 x 70			2
32	GFL.459	Blindflansch	6" (DN150)			2
33	NUS.005	Scheibe	A 13 x 24 x 2,5	DIN 125		18
34	NMS.004	Sechskantmutter	M12			8
35	NGS.031	Stiftschraube	M12 x 30	DIN 938		18
36	NSK.030	Sechskantschraube	M12 x 40	DIN 933		2
37	NMK.002	Sechskantmutter	M12	DIN 985		12

Sicherheitsrelevante Aufkleber

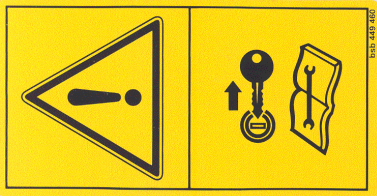
Pos. 38-42

Pos.	Teilenummer	Bezeichnung	Abmessungen	Bemerkung	Rep.	Menge
38	VAU.014	Aufkleber				1
39	VAU.013	Aufkleber				1
40	VAU.011	Aufkleber				1
41	VAU.109	Aufkleber				1
42	VAU.141	Aufkleber				1

Werkzeuge

Pos. 44

Pos.	Teilenummer	Bezeichnung	Abmessungen	Bemerkung	Rep.	Menge
44	WKZ0062	Abziehwerkzeug		Für Rotor		1

Abbildung: elektrischer Antrieb

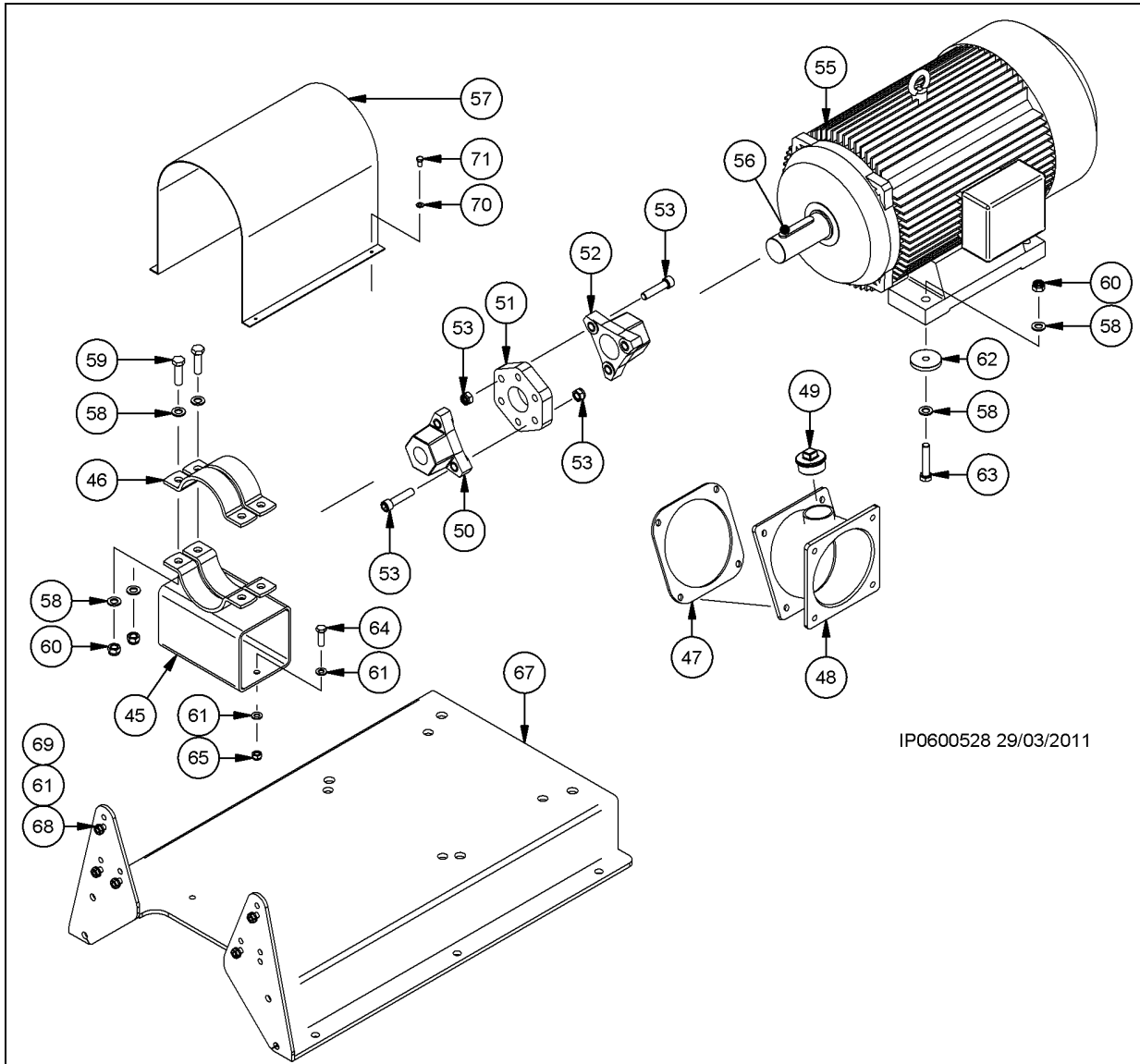

Aufnahme

Pos. 45-46

Pos.	Teilenummer	Bezeichnung	Abmessungen	Bemerkung	Rep.	Menge
45	GST.022	Aufnahme		Antrieb 22 kW		1
	GST0068	Aufnahme		Antrieb 30 kW		
46	GBS.015	Rohrschellen	Ø 133 mm			1

Adapter

Pos. 47-49

Pos.	Teilenummer	Bezeichnung	Abmessungen	Bemerkung	Rep.	Menge
47	DFD.019	Flansch-Dichtung	8"			1
48	GPD.650	Adapter				1
49	NVE.005	Blindstopfen	2"			1

Kupplung HEXAFLEX

Pos. 50-53

Pos.	Teilenummer	Bezeichnung	Abmessungen	Bemerkung	Rep.	Menge
Motor 22 kW						
50	AKU.414	Kupplungsnahe	Ø 42	HEXAFLEX		1
51	AKU.404	Gelenkscheibe		HEXAFLEX		1
52	AKU.411	Kupplungsnahe	Ø 60	HEXAFLEX		1
53	AKU.405	Schraubensatz Kupplung		HEXAFLEX		1

Motor 30 kW

50	AKU.500	Kupplungsnahe	Ø 42	HEXAFLEX		1
51	AKU.505	Gelenkscheibe		HEXAFLEX		1
52	AKU.503	Kupplungsnahe	Ø 65	HEXAFLEX		1
53	AKU.506	Schraubensatz Kupplung		HEXAFLEX		1

Elektromotor und Schutz

Pos. 55-57

Pos.	Teilenummer	Bezeichnung	Abmessungen	Bemerkung	Rep.	Menge
55	AEM0044	Elektromotor	22 kW			1
	AEM0279	Elektromotor	30 kW			
56	NPF.027	Passfeder	A 18 x 11 x 100	DIN6885		1
57	GZS.005G ⁽⁵⁾	Kupplungsschutz ⁽⁵⁾		Elektromotor		1

⁽⁵⁾ Bei Ersatzteilbestellung bitte die Länge angeben!





Schrauben + Zubehör

Pos. 58-71

Pos.	Teilenummer	Bezeichnung	Abmessungen	Bemerkung	Rep.	Menge
58	NUS.007	Scheibe	A 17 x 30 x 3	DIN 125		16
59	NSK.158	Sechskantschraube	M16 x 55	DIN 933		4
60	NMK.007	Sechskantmutter	M16	DIN 985		8
61	NUS.005	Scheibe	A 13 x 24 x 2,5	DIN 125		9
62	PRS0044	Höhenausgleich	9 mm			4
63	NSK.057	Sechskantschraube	M16 x 80	DIN 931		4
64	NSK.030	Sechskantschraube	M12 x 40	DIN 933		2
65	NMK.002	Sechskantmutter	M12	DIN 985		2
67	GBO.198	Konsole				1
68	NMD.001	Sechskantmutter	M12			5
69	NSK.028	Sechskantschraube	M12 x 30	DIN 933		5
70	NUS.003	Scheibe	A; 8,4 x 16 x 1,6	DIN125		4
71	NSK.017	Sechskantschraube	M8 x 16	DIN 933		4





 **Stammhaus / Headquarters
Vogelsang Deutschland West**

**Hugo Vogelsang
Maschinenbau GmbH**
D-49632 Essen/Oldb.

 +49 54 34 83 0
 +49 54 34 83 10
 info@vogelsang-gmbh.com
 www.vogelsang-gmbh.com

 **Vogelsang Deutschland Ost**

Vogelsang Maschinenbau GmbH
D-06295 Lutherstadt Eisleben

 +49 3 47 76 2 05 81
 +49 3 47 76 2 05 82
 rsb@vogelsang-gmbh.com
 www.vogelsang-gmbh.com

 **Vogelsang USA**

Vogelsang USA Ltd.
US-Ravenna, OH 44266

 +1 33 02 96 38 20
 +1 33 02 96 41 13
 sales@vogelsangusa.com
 www.vogelsangusa.com





 **Vogelsang Danmark**

Vogelsang A/S
DK-6880 Tarm

 +45 97 37 27 77
 +45 97 37 30 77
 vogelsang@adr.dk
 www.vogelsang.info

 **Vogelsang Great Britain**

Vogelsang Ltd.
GB-Crewe, Cheshire CW1 6YY

 +44 12 70 21 66 00
 +44 12 70 21 66 99
 sales@vogelsang.co.uk
 www.vogelsang.co.uk



 **Vogelsang France**

Vogelsang France S.A.R.L.
F-26740 Montboucher Sur Jabron

 +33 4 75 52 74 50
 +33 4 75 52 76 61
 info@vogelsang.fr
 www.vogelsang.fr





 **Vogelsang Italia**

Vogelsang S.r.l.
IT-26025 Pandino (CR)

 +39 03 73 22 03 12
 +39 03 73 91 08 7
 info@vogelsang-srl.it
 www.vogelsang-srl.it





 **Vogelsang España**

Vogelsang S.L.
ES-43800 Valls (Tarragona)

 +34 977 60 67 33
 +34 977 60 67 33
 info@vogelsang.es
 www.vogelsang.es





 **Vogelsang Polska**

Vogelsang Sp. z o.o.
PL-52-214 Wroclaw

 +48 71 79 89 58 0
 +48 71 79 89 58 2
 info@vogelsang.pl
 www.vogelsang.pl





 **Vogelsang Romania**

Vogelsang Romania SRL
RO-021041 Bucuresti

 +40 75 31 05 77 7
 +40 31 42 72 75 7
 info@vogelsang.ro
 www.vogelsang.ro



 **Vogelsang Malaysia**

Vogelsang Malaysia
MY-52200 Kuala Lumpur

 +60 1 22 11 42 23
 +60 3 62 72 91 87
 chan@vogelsang-gmbh.com
 www.vogelsang.info





 **Vogelsang China**

**Vogelsang Mechanical Engineering
(Shanghai) Co., Ltd.**
CN-Shanghai 200436

 +86 21 61 39 85 01
 +86 21 61 39 85 02
 sales@vogelsang.com.cn
 www.vogelsang.com.cn

 **Vogelsang Australia**

Vogelsang Pty Ltd.
AU-Peakhurst NSW 2210

 +61 2 9534 5984
 +61 2 533 7349
 info@vogelsang.com.au
 www.vogelsang.com.au





 **Vogelsang India**

Vogelsang India Pvt. Ltd.
IN-Noida, 201301 (Uttar Pradesh)

 +91 120 42 12 901 06
 +91 965 09 14 499 (mobile)
 +91 120 42 12 908
 info@vogelsangindia.com
 www.vogelsangindia.com



 **Vogelsang Česká Republika**

Vogelsang CZ s.r.o.
CZ-163 00 Praha 6

 +420 277 270 119
 +420 277 270 919
 info@vogelsang-czech.cz
 www.vogelsang-czech.cz



 **Vogelsang Brasil**

Vogelsang Brasil Ltda.
BR-Vinhedo, SP 13280-000

 +55 11 6599 9676
 ricardo.bordon@vogelsang.com.br
 www.vogelsang.com.br

 **Vogelsang México**

Vogelsang De México S de R.L. de C.V.
MX-México City, DF CP 02300

 +52 1 55 35 02 38 87
 enriqueg@vogelsangusa.com
 www.vogelsang.mx